

GN4 N

ISO 9001 : 2000
CERTIFIED COMPANY



- GB** high-efficiency cast iron boiler for liquid fuels and/or gas
OPERATING, INSTALLATION AND MAINTENANCE INSTRUCTIONS
- IT** caldaia di ghisa ad alto rendimento per combustibili liquidi e/o gassosi
ISTRUZIONI PER L'USO L'INSTALLAZIONE E LA MANUTENZIONE
- FR** chaudière en fonte a haut rendement pour combustibles liquides et/ou gazeux
INSTRUCTIONS POUR L'INSTALLATION ET L'ENTRETIEN
- DE** heizkessel aus gusseisen mit hohem wirkungsgrad für flüssige und/oder gasförmige brennstoffe
INSTALLATIONS-, BEDIENUNGS- UND WARTUNGSANLEITUNGEN
- ES** caldera de fundición, de alto rendimiento para combustibles líquidos y/o gaseosos
INSTRUCCIONES DE USO, INSTALACIÓN Y MANTENIMIENTO
- PT** caldeira em ferro fundido de alto rendimento para combustíveis líquidos e/ou gasosos
INSTRUÇÕES PARA O USO, INSTALAÇÃO E MANUTENÇÃO
- NL** verwarmingsketel in gietijzer met hoog rendement voor vloeibare en/of gasvormige brandstof
AANWIJZINGEN VOOR HET GEBRUIK, DE INSTALLATIE EN HET ONDERHOUD
- DK** støbejernsfyr med øget udbytte til flydende brændstof og/eller gas
INSTRUKTIONER VEDRØRENDE BRUG, INSTALLATION OG VEDLIGEHOLDELSE
- TR** sivi ve/veya gaz yakitli yüksek verimli
DÖKÜM DÖLMLÖ KAZAN

ENGLISH

Dear Customer,

Thank you for having chosen the **GN4 N**, an advanced-concept Ferrolli boiler featuring cutting-edge technology, high reliability and constructional quality. Carefully read this manual and keep it for future reference.

The **GN4 N** is a high-efficiency heat generator for the production of hot water for heating purposes, suitable for operation with jet burners on gas or liquid fuel.

The boiler body consists of cast-iron elements, the shape of which, together with the careful design of the fins, ensure high heat exchange efficiency in all operating conditions.



Important warnings

- This manual provides important indications on the safety of operation, installation and maintenance, and is an integral and essential part of the product. Read this manual before installation and operation. It should be carefully kept for future reference.
- This appliance must only be used for the purposes it has been specifically designed for. This appliance is used to heat water to below-boiling temperatures at atmospheric pressure, and must be connected to a heating and/or domestic hot water distribution system, according to its characteristics, performance and heating capacity. All other uses are considered improper and thus dangerous.
- The appliance may not be opened nor its components tampered with, except for the parts included in the maintenance operations. The appliance may not be modified to alter its performance or use.
- The installation and maintenance operations must be performed according to the standards in force, the instructions of the manufacturer and must be carried out by professionally qualified personnel.
- Incorrect installation or poor maintenance may cause damage to people, animals or things. The manufacturer declines all liability for damage deriving from errors in the installation and operation of the appliance, and in any case from the failure to observe the instructions provided.
- Before performing any cleaning or maintenance operations, disconnect the appliance from the mains power supply using the system switch and/or the corresponding on-off devices.
- In the event of faults and/or poor operation of the appliance, it should be deactivated. Do not attempt to repair the appliance. Contact professionally qualified personnel only.
- After having removed the packaging, check that the contents are intact. The parts of the packaging must not be left within the reach of children, as they are potential sources of danger.

	08/250		
Serial number	Appr. nr.	Ser. n. 0352L50349	
Heat output	Q	max 270 - min 160	kW
Useful heat output	P	250 - 150	kW
Max operating pressure	PMS	6	bar
	tmax	100	°C
	PMW		bar
	D		l/min
Electrical power supply		230V~50Hz	IP X 0D
		H ₂ O	163 L
PIN		0085 0085AS0589	

Max operating pressure temperature

Water content

Bar code



Certification

The CE Mark attests that Ferrolli appliances conform to the requirements specified in the applicable European directives.

In particular, this appliance conforms to the following EEC directives:

- Gas directive 90/396
- Efficiency directive 92/42
- Low voltage directive 73/23 (amended by 93/68)
- Electromagnetic compatibility directive 89/336 (amended by 93/68)

1. OPERATING INSTRUCTIONS

1.1 Control panel

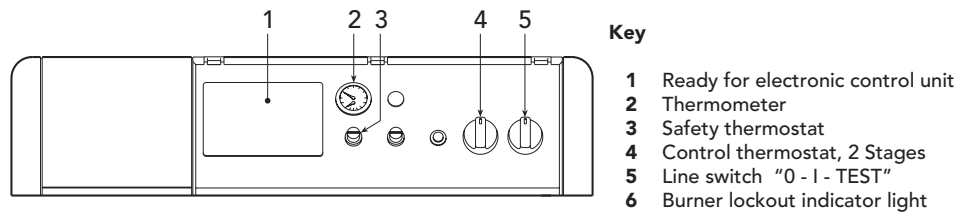

Key

- 1 Ready for electronic control unit
- 2 Thermometer
- 3 Safety thermostat
- 4 Control thermostat, 2 Stages
- 5 Line switch "0 - I - TEST"
- 6 Burner lockout indicator light

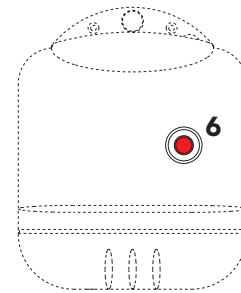

fig. 1

1.2 Ignition

Move the main switch **5** to position "I" to power the boiler and the burner. Refer to the burner manual for the operation of this device.

1.3 Setting

Set the desired system temperature using the control thermostat **4**. If the thermoregulation control unit (optional) is connected, refer to the corresponding instruction manual.

1.4 Shut-down

For brief periods of inactivity, simply move switch **5** (Fig. 1) on the control panel to position "0".

For extended periods of inactivity, as well as operating switch **5**, the fuel on-off valve must also be closed.

For extended periods of inactivity during the winter period, to avoid damage from frost, add special antifreeze to the system or drain the system completely.

1.5 Anomalies

Two lockout conditions may occur that can be reset by the user:

a - Burner lockout signalled by the corresponding light **6** (Fig. 1). Refer to the burner manual.

b - Activation of the safety thermostat when the temperature in the boiler reaches the limit value above which a dangerous situation may arise. To reset operation, unscrew cap **3** and press the reset button.

If the problem occurs again, contact qualified personnel or the service centre. In the event of faults and/or poor operation of the appliance, it should be deactivated. Do not attempt to repair the appliance. Contact professionally qualified and authorised personnel only.

2. INSTALLATION

General instructions

This appliance must only be used for the purposes it has been specifically designed for. This appliance is used to heat water to below-boiling temperatures at atmospheric pressure, and must be connected to a heating and/or domestic hot water distribution system, according to its characteristics, performance and heating capacity. All other uses are considered improper.



THE BOILER MUST ONLY BE INSTALLED BY QUALIFIED AND SPECIALIST PERSONNEL, IN COMPLETE COMPLIANCE WITH ALL THE INSTRUCTIONS REPORTED IN THIS TECHNICAL MANUAL, THE LEGAL STANDARDS IN FORCE, THE PRESCRIPTIONS OF ANY NATIONAL AND LOCAL STANDARDS, AND ACCORDING TO THE RULES OF GOOD PRACTICE.

Incorrect installation may cause damage to people, animals and things. The manufacturer will not be held liable in such events.

Place of installation

The room in which the boiler is installed must have ventilation openings to the outside according to the standards in force. If the same room features a series of burners or exhaust devices that can operate at the same time, the ventilation openings must be large enough for the simultaneous operation of all the appliances.

The place of installation must be free of flammable objects or materials, corrosive gas, dust or volatile substances that, sucked in by the burner's fan, may block the internal tubing of the burner or the combustion head. The environment must be dry and not exposed to rain, snow or frost.

Positioning the boiler

The minimum spaces shown in the figure must be complied with. Specifically, make sure that after assembling the boiler with the burner on the front door, the latter can be opened without the burner hitting against the wall or any other boiler. Leave a free space of at least 100mm on the side that the door swings towards.

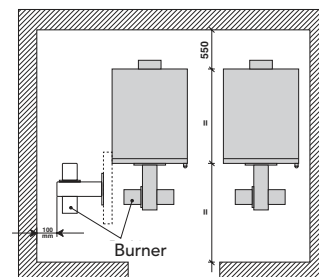

fig. 2

English

Italiano

Français

Deutsch

Español

Português

Nederlands

Dansk

Türkçe



2.1 Water connections

Make the water connections to the appliance according to the indications shown both next to each fitting and in Figure 2 of this booklet.

The connections must be made in such a way that the pipes are not under stress. The safety valve must be fitted in the central heating circuit, as close as possible to the boiler, without there being any obstructions or on-off devices between the boiler and the valve.

The appliance is not supplied with an expansion vessel, and therefore such device must be connected by the installer. Please note that in this regard, the pressure in the system, when cold, must be between 0.5 and 1 bar.

2.2 Connecting the burner

Oil or gas jet burners for pressurised furnaces can be used if their operating characteristics are suitable for the dimensions of the boiler's furnace and its over-pressure value. The burner must be chosen following the instructions provided by the manufacturer, according to the field of operation, fuel consumption and pressure, as well as the length of the combustion chamber.

Fit the burner following the instructions provided by the manufacturer of the device.

2.3 Electrical connections



The boiler should be connected to a single-phase, 230 Volt-50 Hz electrical line, using a permanent connection, installing a double pole switch with contact openings of at least 3mm, and suitable fuses. Connect the burner and the room thermostat (if featured) as shown in the wiring diagram in Chap. 4.

The electrical safety of the appliance is ensured only when the appliance is correctly connected to an effective earth system, as prescribed by the safety standards in force. Have professionally qualified personnel check the efficiency and the rating of the earth system. The manufacturer is not liable for any damage caused by the appliance not being correctly earthed. In addition, make sure that the electrical system is adequately rated for the maximum power absorbed by the appliance, indicated on the rating plate, and in particular that the cross-section of the wires is suitable for the power absorbed by the appliance.

2.4 Flue connections

The boiler should be connected to a suitable flue, manufactured in compliance with the standards in force. The pipe between boiler and the flue must be made from material suitable for this purpose, that is, resistant to both high temperatures and corrosion. The joints should be carefully sealed and the entire length of the pipe between the boiler and the flue should be thermally insulated, to avoid the formation of condensate.

2.5 Assembling the boiler

The boiler may be supplied:

- As a set of elements, in 4 separate boxes, containing the Casing, Control panel, Elements, and accessories for assembling the elements.

Follow the instructions enclosed with the set of elements to assemble the boiler body. Follow the instructions below to assemble the casing and control panel.

- With the body already assembled, in 3 separate boxes containing the Casing, Control panel and Boiler body. Follow the instructions below to assemble the casing and the control panel.

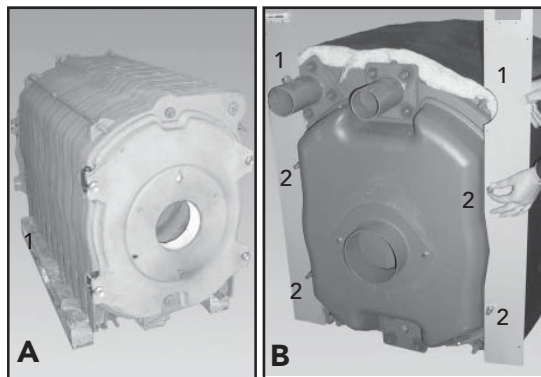

- A** If the boiler body is supplied already assembled and is delivered from the factory on a pallet, remove the bolts **1** that fasten it to the pallet and position it for final installation. Then assemble the various panels.
- B** Fit the rear panel **1** on the studs **2** and loosely tighten the bolts.

Element	Configuration	Configuration	Configuration	Configuration
7 elem.	F. a. DX + SX + C. a.	F. 3 + C. 3		
8 elem.	F. a. DX + SX + C. a.	F. 1 + C. 1	F. 1 + C. 1	
9 elem.	F. a. DX + SX + C. a.	F. 2 + C. 2	F. 1 + C. 1	
10 elem.	F. a. DX + SX + C. a.	F. 2 + C. 2	F. 2 + C. 2	
11 elem.	F. a. DX + SX + C. a.	F. 2 + C. 2	F. 3 + C. 3	
12 elem.	F. a. DX + SX + C. a.	F. 3 + C. 3	F. 3 + C. 3	
13 elem.	F. a. DX + SX + C. a.	F. 1 + C. 1	F. 2 + C. 2	F. 2 + C. 2
14 elem.	F. a. DX + SX + C. a.	F. 2 + C. 2	F. 2 + C. 2	F. 2 + C. 2

C	7 elem.	9÷12 elem.	13÷14 elem.
----------	---------	------------	-------------

Side panels

F. a. DX = 330 mm (cod. 3703812/0)
 F. a. SX = 330 mm (cod. 3703813/0)
 F. 1 = 406 mm (cod. 3703814/0)
 F. 2 = 536 mm (cod. 3703815/0)
 F. 3 = 666 mm (cod. 3703816/0)

Cover

C. a. = 273 mm (cod. 3703822/0)
 C. 1 = 406 mm (cod. 3703819/0)
 C. 2 = 536 mm (cod. 3703820/0)
 C. 3 = 666 mm (cod. 3703821/0)

- C** Prepare the right and left sides, choosing the quantity of side panels according to the dimensions of the boiler (see table).

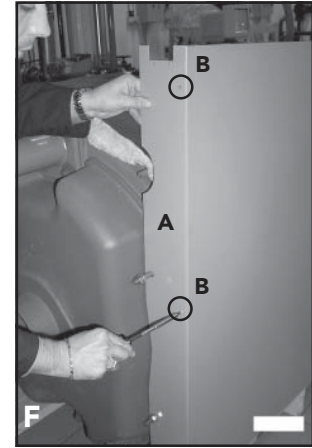
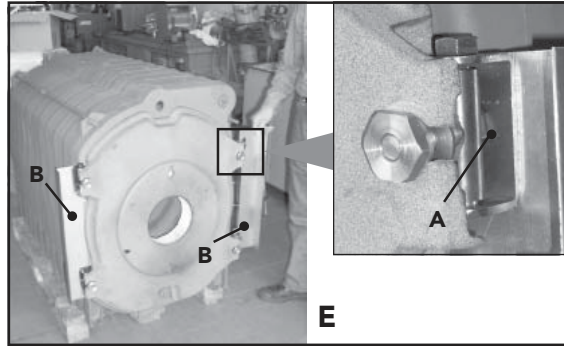
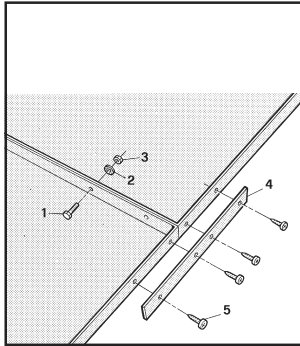

- D** Connect the panels together, using the screws 1, the washers 2 and the nuts 3, reinforcing the bottom parts using the blades 4 fastened with the screws 5.
- E** Loosen the nuts "A". Insert the side fastening bracket "B"
- F** Fasten the sides to the rear wall "A" using the screws "B".

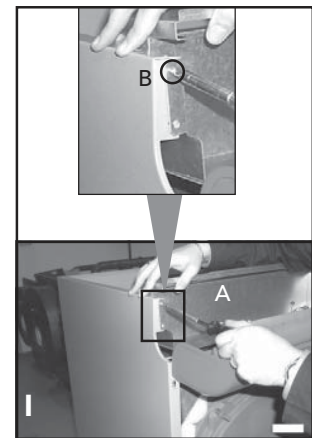
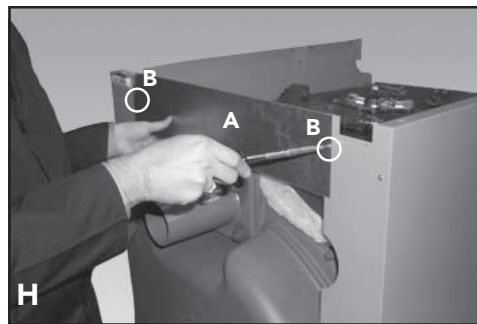
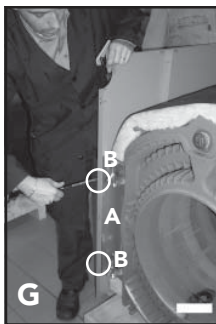

- G** Fit the side to the bracket "A" and fasten it using the screws "B" (right side view). Repeat the operations in point G for the left side.
- H** Fasten the sides to the rear wall "A" using the screws "B".
- I** Fit the wiring protection case "A" using the screws "B" on the sides.

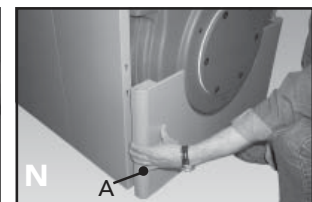
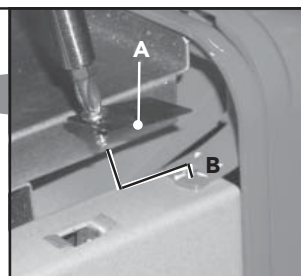
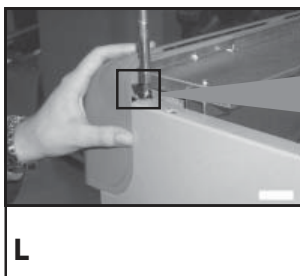

- L** Fit the control panel to the sides using the tabs "A". Place the reinforcement spring "B" between the head of the screw and the tab.

- M** Insert the 3 bulbs (safety thermostat, boiler thermostat and thermometer).
- N** Fit the lower front panel "A".



- O** Fit the upper panel "A".
- P** Fit the top cover or covers "A", according to the length of the boiler (see table 1, sequence C).

English

Italiano

Français

Deutsch

Español

Português

Nederlands

Dansk

Türkçe

English
Italiano
Français
Deutsch
Español
Português
Nederlands
Dansk
Türkçe

3. SERVICE AND MAINTENANCE

All the adjustment, commissioning and maintenance operations must be performed by Qualified Personnel, in compliance with the standards in force.

FERROLI S.p.A. declines all liability for damage to persons and/or things deriving from the tampering with the appliance by unqualified or unauthorised persons.

Before performing any cleaning or maintenance operations, disconnect the appliance from the mains power supply using the system switch and/or the special on-off devices.

3.1 Commissioning

Checks to be performed on first ignition, and after all maintenance operations that involve the disconnection of the appliance from the systems or intervention on the safety devices or parts of the boiler:

Before first ignition

Before igniting the boiler for the first time, check that:

- a the system is filled at the right pressure and any air has been correctly vented;
- b there are no water or fuel leaks;
- c the electrical power supply is correct;
- d all the flues have been installed correctly and not too near to or across any flammable parts;
- e there are no flammable substances near the appliance;
- f the burner is suitably sized for the output of boiler;
- g the water on-off valves are open.

First ignition

After having carried out the preliminary checks, the following ignition operations can be performed:

- 1 Open the fuel on-off valve.
- 2 Set the thermostat 4 (Fig. 1) to the desired value.
- 3 Close the switch upstream from the boiler and switch 5 (Fig. 1) on the control panel.

At this stage, the burner will be ignited and the boiler will start operation.

After first ignition

After first ignition, check that:

- 1 The door of the burner and smokebox are well sealed.
- 2 The burner is working correctly. This check should be performed using the required instruments, following the manufacturer's instructions.
- 3 The thermostats are working correctly.
- 4 Water is circulating in the system.
- 5 The flue gas is completely expelled through the flue.

3.2 Adjustments

Adjusting the burner

The efficiency and correct operation of the boiler depend above all on accuracy of the adjustments made to the burner. Carefully follow the instructions provided by the manufacturer. Two-stage burners must have the first stage adjusted to an output that is no lower than the minimum rated output of the boiler. The output of the second stage must not be greater than the maximum rated output of the boiler.

3.3 Shut-down

For brief periods of inactivity, simply use switch 5 (Fig. 1) on the control panel.

For extended periods of inactivity, as well as operating switch 5, the fuel on-off valve must also be closed.

3.4 Maintenance

To ensure the maximum reliability of the heating system and minimum running costs, the boiler must be cleaned regularly, at least once a year. These maintenance operations must be performed by qualified and specialist personnel.

Cleaning the boiler

- 1 Disconnect the power supply to the boiler
- 2 Remove the upper and lower front panel.
- 3 Open the door by unscrewing the knobs.
- 4 Clean the inside of the boiler and the entire flue gas discharge path, using a brush or compressed air.
- 5 Close the door again, and fasten it using the knob.

To clean the burner, refer to the instructions provided by the manufacturer.

4. TECHNICAL SPECIFICATIONS

Modello	Heat input gas+oil (NHV) kW		Heat output kW		N° elem.	Water content dm3	Operating pressure bar	A	B	C	D	E	Comb. chamber pressure drop Δp mbar	Comb. chamber volume dm3	Water pressure drop		Body weight kg
	Max	Min	Max	Min				mm	\varnothing mm	\varnothing mm	\varnothing mm	mm			Δt 10	Δt 20	
GN4 N 07	217	128	200	120	7	143	6	1040	210	180	500	880	0,5	161,3	-	20	840
GN4 N 08	270	160	250	150	8	163	6	1170	210	180	500	1010	0,8	185,1	-	30	950
GN4 N 09	324	192	300	180	9	183	6	1300	210	250	500	1140	0,7	208,9	-	42	1060
GN4 N 10	388	229	360	215	10	203	6	1430	210	250	500	1270	1,0	232,8	-	54	1170
GN4 N 11	452	266	420	250	11	223	6	1560	210	250	500	1400	1,4	256,6	-	65	1280
GN4 N 12	516	309	480	290	12	243	6	1690	210	250	500	1530	1,7	280,4	-	77	1390
GN4 N 13	600	352	560	330	13	263	6	1820	210	250	500	1660	2,6	304,3	-	88	1500
GN4 N 14	695	416	650	390	14	283	6	1950	210	250	500	1790	3,5	328,1	-	100	1610

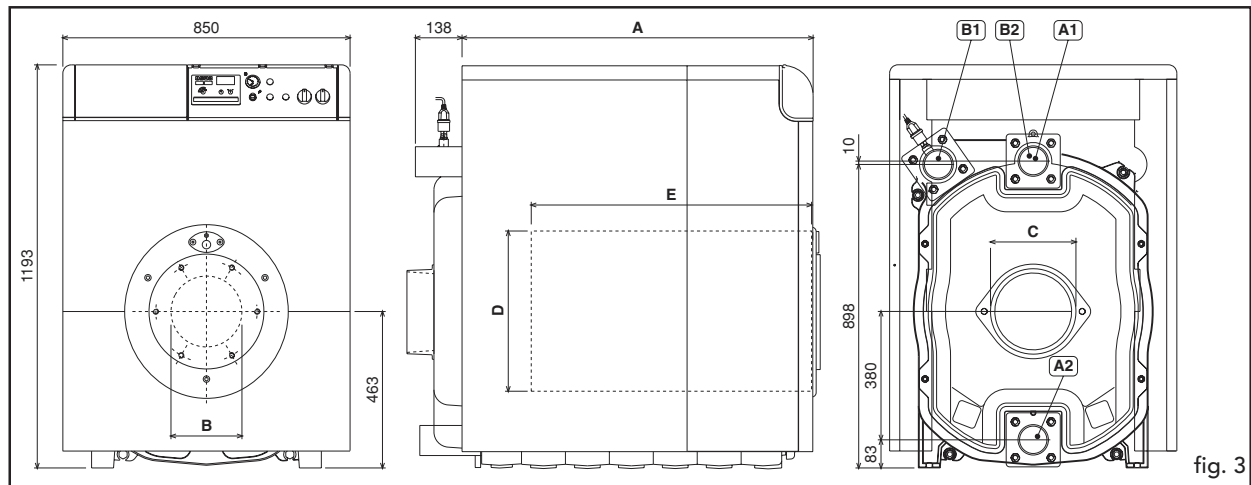

fig. 3

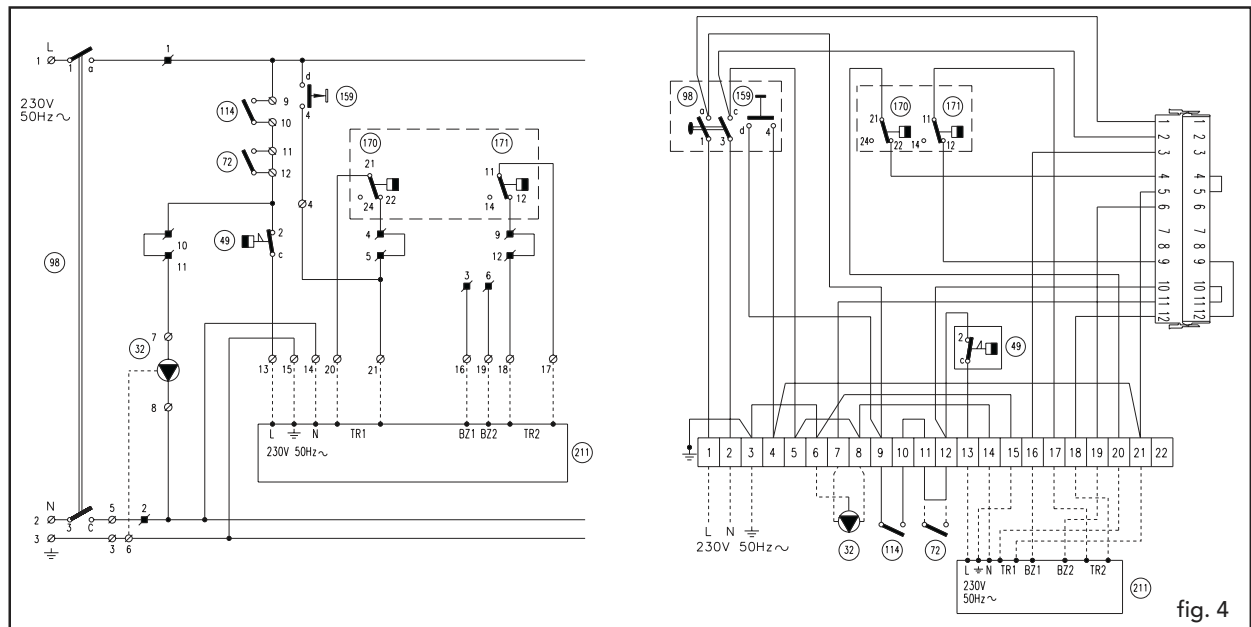

fig. 4

Legenda

- | | |
|--|---|
| A1 Central heating flow outlet DN80 - 3" | 72 Room thermostat (not supplied) |
| A2 Central heating return inlet DN80 - 3" | 98 Switch |
| B1 Central heating flow outlet DN80 - 3" (Low temperature) | 114 Water pressure Switch |
| B2 Central heating return inlet DN80 - 3" (Low temperature) | 159 Test knob |
| 32 Pump (not supplied) | 170 Boiler setting thermostat, 1 st stage |
| 49 Safety thermostat | 171 Boiler setting thermostat, 2 nd stage |
| | 211 Burner connector |

Note The dashed sections of wiring are the responsibility of the installer